

» reliably
efficient!



GEA biosolids Decanter prime

Energy consumption reduced by up to 50 %



gea.com

Outstanding Energy Efficiency of GEA biosolids Decanter prime

GEA biosolids Decanter prime achieves first-class separation results whether as a stationary or a mobile unit. This applies to the dewatering and concentration of sewage sludge, the treatment of drinking water and the recovery of valuable materials.

In times of rising disposal costs and energy prices, the operating costs of a decanter are becoming more important than ever. Numerous technical innovations in the GEA biosolids Decanter prime ensure a uniquely favourable energy balance and first-class separation performance. The specific energy consumption of the GEA biosolids Decanter prime has been reduced by up to 50% overall.

This means the decanter now requires only 0.5 kWh for each cubic metre of thickened sludge. We have also managed to reduce flocculent consumption, rendering water and waste water treatment more sustainable and ensuring that your investment holds its value for longer.

The outstanding efficiency and productivity are based on the following technical features:

- GEA ecodrive
- GEA summationdrive
- GEA deep-pond design
- GEA energyjets

Reduced Energy Consumption

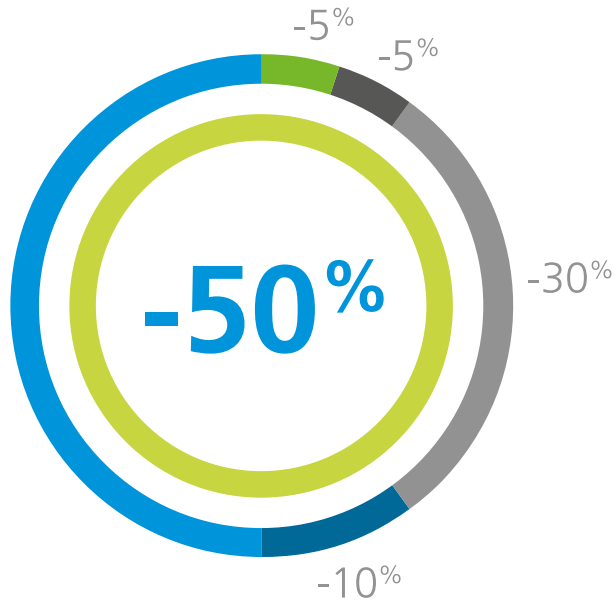

■ GEA biosolids Decanter prime
■ Earlier generation of decanters

■ GEA ecodrive
■ GEA summationdrive

■ GEA deep-pond design
■ GEA energyjets

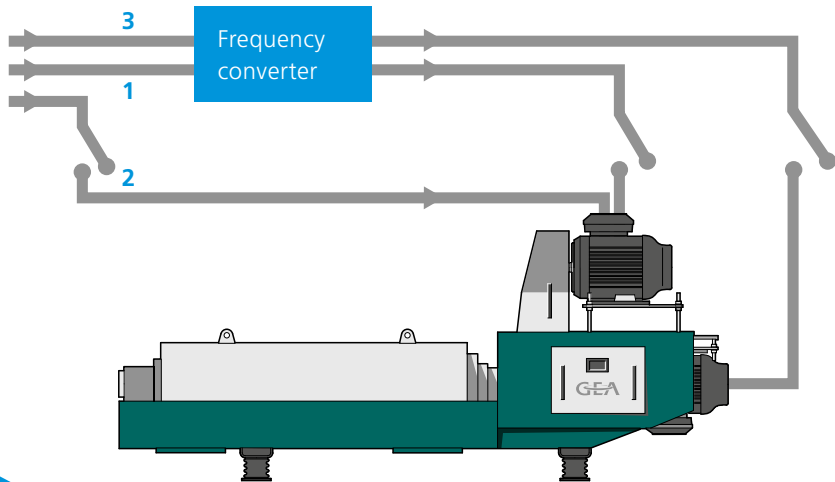

- 1 Start main motor with frequency converter up to bowl speed
- 2 Switch main motor direct on line
- 3 2nd motor with frequency converter up to required differential speed

GEA ecodrive



Whilst earlier generations of decanter centrifuges had two separate frequency converters to drive the bowl and scroll, GEA biosolids Decanter prime is controlled by just one frequency converter.

The frequency converter of the secondary motor starts the primary motor when the machine starts up. Once the decanter bowl has reached its rated speed, the machine switches to mains operation and the frequency converter is applied to the secondary motor where it now controls the differential speed. This saves one frequency converter in the control unit and eliminates the loss of efficiency caused by a frequency converter. This has allowed energy consumption to be reduced by a further 5%.



GEA summationdrive

The intelligent kinematics of summationdrive bring together (“sum”) the outputs of both motors and then transmit them precisely to bowl and scroll. Unnecessary conversion losses, such as those which occur in other solutions involving reverse power (backdrive or additional belts), are not an issue with summationdrive. Instead, differential speed is supplied energy-efficiently and seamlessly across a broad range, saving up to 5 % energy compared to other drives.

As a result, any additional electrical components for recycling energy can be dispensed with.

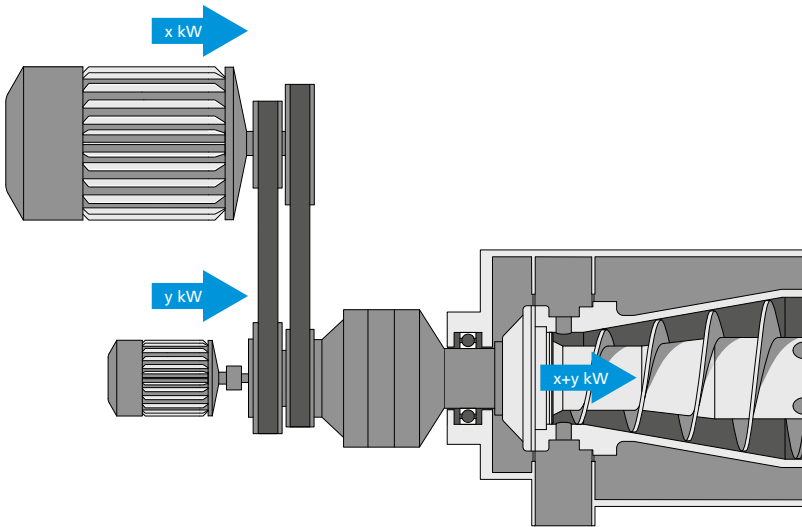



GEA deep-pond Design

The deep-pond design of bowls in the GEA biosolids Decanter prime ensures optimized flow characteristics in the bowl, improved clarification and a reduced energy requirement for discharging the product. This reduces electricity consumption by up to 30% and also dramatically cuts the requirement for flocculents.

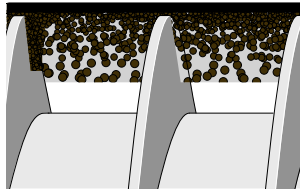

Shallow pond

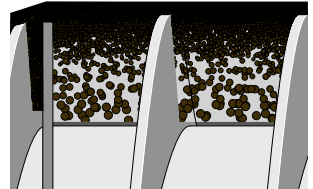

deep-pond

**Pond depth is dependent on application – bowls with a shallow pond have to be used for dewatering or classifying purposes, for example.*

MAXIMUM SEPARATION EFFICIENCY – **DEEP-POND** *

The deeper the pond, the higher the hydrostatic pressure on the separated solids at the bowl shell and the smaller the particles which can be separated.

GEA energyjets



One source of energy consumption in a decanter centrifuge is the power required to discharge the clarified liquid. This can represent up to 50% of the decanter's total energy requirement. Using energyjets, specially-shaped weir plates with integrated flow deflection allow the decanter's energy requirement to be reduced by up to 10%.

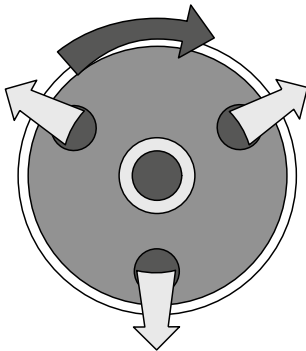

Conventional liquid outlet

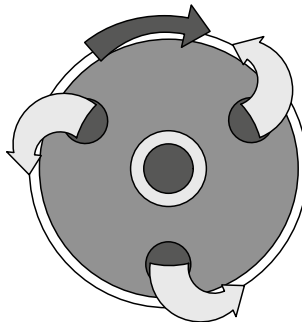

GEA energyjets



We live our values.

Excellence • Passion • Integrity • Responsibility • GEA-versity

GEA is a global technology company with multi-billion euro sales operations in more than 50 countries. Founded in 1881 the company is one of the largest providers of innovative equipment and process technology. GEA is listed in the STOXX® Europe 600 Index. In addition, the company is included in selected MSCI Global Sustainability Indexes.

GEA Germany

GEA Westfalia Separator Group GmbH
Werner-Habig-Straße 1
59302 Oelde, Germany

Tel +49 2522 77-0
Fax +49 2522 77-2950
sales.germany@gea.com | gea.com